

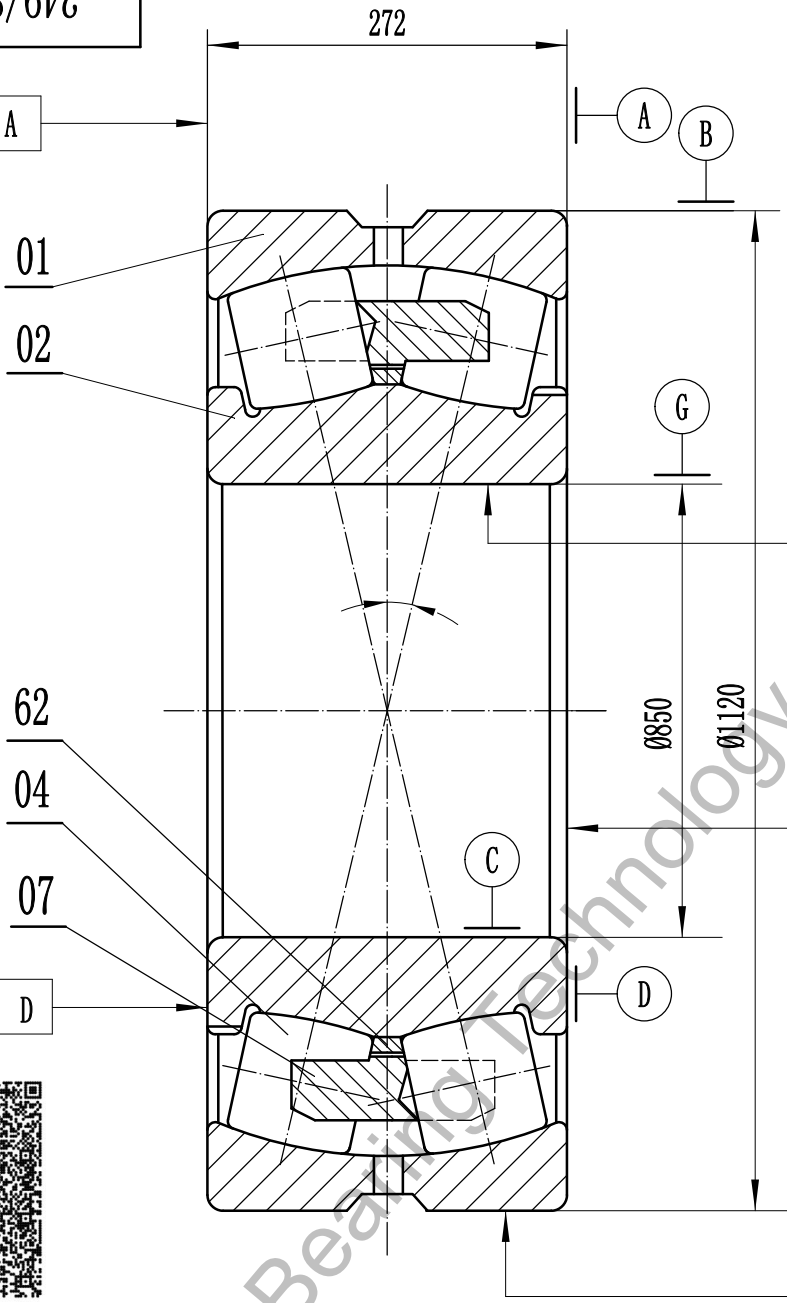

/// V<sub>Cs</sub> A



⊖ V<sub>dsp</sub>  
 ⊘ V<sub>dmp</sub>  
 ⚡ K<sub>ia</sub> B

⚡ S<sub>d</sub> G

/// V<sub>Bs</sub> D



⊖ V<sub>Dsp</sub>  
 ⊘ V<sub>Dmp</sub>  
 ⚡ K<sub>ea</sub> C  
 ✓ S<sub>D</sub> A

- 1、Tolerance of running accuracy are according to relevant state standard;
- 2、The value of the basic group of radial clearance:min \*\*\*\* max \*\*\*\*;
- 3、Rated load: Cr= \*\*\*\* kN Cor= \*\*\*\* kN.

62	Guide ring	Steel 20—GB/T699			
07	Cage	Brass CuZn39Pb2—EN 1652:1997			
04	Roller	Steel 100CrMnSi6-4—ISO 683-17:1999			
02	Inner ring	Steel 100CrMnSi6-4—ISO 683-17:1999			
01	Outer ring	Steel 100CrMnSi6-4—ISO 683-17:1999			

No.	Designation	Qty	Material	unit	toatl	Remark
				Weight (kg)		

Luoyang JCB Bearing Technology Co., Ltd  
 Contact information  
 Company Address : No. 285, Fenghua road,  
 Luoyang, Henan, China.  
 Postal code : 471000  
 Phone :86-379-68611678  
 Fax : 86-379-68611679  
 E-mail: sales@jcb-bearing.com  
 Reserved E-mail: sales@sphericalrollerbearing.net  
 Website: www.jcb-bearing.com  
 www.sphericalrollerbearing.net

### Spherical Roller Bearing

249/850 CA/W33

			Weight(kg)	Scale
S				—
Total page 5			Page No. 1	